

CUSTOMER: \_\_\_\_\_

DATE: \_\_\_\_\_

## For Automotive Electronics

# APPROVAL SPECIFICATION



PRODUCT NAME: SMD Wire Wound Chip Inductor

YOUR PART NO.:

OUR PART NO.: AMTF0805W Series

VERSION: V1.0

<b>RECEPTION</b> <b>THE SPECIFICATION HAS BEEN ACCEPTED.</b>		
<b>DATE:</b>		
<b>COMPANY:</b>		
<b>CFMD</b>	<b>CHKD</b>	<b>RCVD</b>

MANUFACTURING NAME

SHENZHEN MICROGATE TECHNOLOGY CO., LTD  
 Address: Microgate Technology Building, No. 16,  
 Technology Road, Pingshan, Shenzhen, China.  
 Postcode: 518122  
 TEL: 86-755-28085000  
 FAX: 86-755-28085605

CFMD.	CHKD.	DSGD.
Remo	-	Wei Liu

CATALOG

	<b>Component SPEC Version Record.....</b>	<b>3</b>
<b>1</b>	<b>Scope.....</b>	<b>4</b>
<b>2</b>	<b>Product Identification.....</b>	<b>4</b>
<b>3</b>	<b>Appearance, Dimensions and Material.....</b>	<b>4</b>
<b>4</b>	<b>Testing Conditions.....</b>	<b>4</b>
<b>5</b>	<b>Rating.....</b>	<b>5</b>
<b>6</b>	<b>Electrical Characteristics.....</b>	<b>6</b>
<b>7</b>	<b>Reliability.....</b>	<b>7-9</b>
<b>8</b>	<b>Recommended Soldering Condition.....</b>	<b>10-11</b>
<b>9</b>	<b>Packaging.....</b>	<b>12</b>
<b>10</b>	<b>Storage.....</b>	<b>13</b>
<b>11</b>	<b>Transportation.....</b>	<b>13</b>
<b>12</b>	<b>Warning and Attentions.....</b>	<b>13-14</b>
<b>13</b>	<b>Cleaning.....</b>	<b>15</b>
<b>14</b>	<b>Measuring Method of Inductance.....</b>	<b>15</b>

### Component SPEC Version Record

Rev.	Effective Date	Changed Contents	Change Reasons	Approved By
1.0	2019.09.25	New released	/	Remo

## 1. Scope

This specification applies to the AMTF0805W series of SMD Wire Wound Chip Inductors.

## 2. Product Identification

AMTF 0805 W R47 J S T  
 ① ② ③ ④ ⑤ ⑥ ⑦

- ① Product Symbol(Automotive electronics products)
- ② Dimensions (0805 inch)
- ③ Features
- ④ Inductance Value (1N6:1.6nH 27N:27nH; R47:470nH; 1R0:1.0uH)
- ⑤ Inductance Tolerance

Code	G	H	J
Tolerance	±2%	±3%	±5%

- ⑥ Termination materials (G: gold ; S: sn)
- ⑦ Packaging style ( T: Taping ; B: Bulk )

## 3. Appearance, Dimensions and Material

### (1) Appearance and dimensions

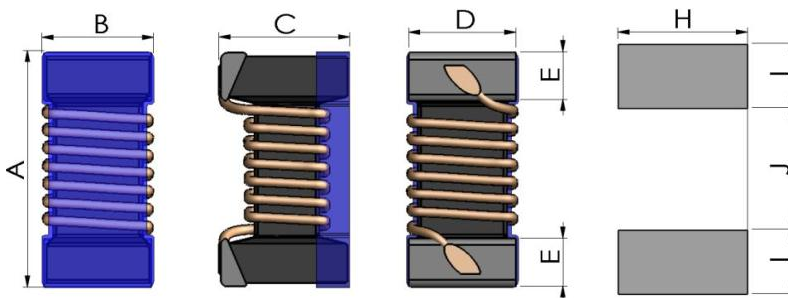

Dimensions in mm								
A Max.	B Max.	C Max.	D ref	E ref	F ref	H ref	I ref	J ref
2.29	1.73	1.52	0.51	0.41	1.02	1.78	1.02	0.76

### (2) Material List

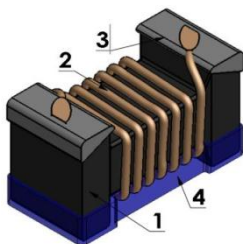

No.	Item	Material
1	Core	Ferrite
2	Wire	Enameled Copper Wire
3	Terminal Electrode	Sn
4	Coating	Ultraviolet epoxy resin

## 4. Testing Conditions

Unless otherwise specified, the standard conditions for measurement/test as:

Ambient Temperature : 5 to 35°C  
 Relative Humidity: 25 to 85% RH  
 Atmospheric Pressure: 86 to 106 kPa

If any doubt on the results, measurements/tests should be made within the following limits:

Ambient Temperature : 25±1°C  
 Relative Humidity: 60 to 70% RH  
 Atmospheric Pressure: 86 to 106 kPa

SHENZHEN MICROGATE TECHNOLOGY CO., LTD.

Add: Microgate Technology Building, No. 16, Technology Road, Pingshan, Shenzhen, China.

Tel: +86-755-28085000

Fax: +86-755-28085605

Postcode: 518122

## 5. Rating

Operating temperature: -55°C~150°C

Microgate Part No.	Inductance (uH)	Tolerance	Q (min.)	L/Q Test Frequency (MHz)	DC Resistance (Ω max.)	Rated Current (mA)	SRF (MHz) (min.)
AMTF0805WR12□ST	0.12	J,K	19	7.9	0.27	750	340
AMTF0805WR15□ST	0.15	J,K	19	7.9	0.30	720	480
AMTF0805WR18□ST	0.18	J,K	19	7.9	0.40	720	480
AMTF0805WR22□ST	0.22	J,K	19	7.9	0.40	720	480
AMTF0805WR39□ST	0.39	J,K	19	7.9	0.31	720	500
AMTF0805WR47□ST	0.47	J,K	19	7.9	0.31	720	500
AMTF0805WR56□ST	0.56	J,K	12	7.9	0.46	400	400
AMTF0805WR68□ST	0.68	J,K	12	7.9	0.46	590	400
AMTF0805WR81□ST	0.81	J,K	12	7.9	1.00	520	360
AMTF0805WR88□ST	0.88	J,K	12	7.9	1.00	520	360
AMTF0805WR91□ST	0.91	J,K	12	7.9	1.00	430	360
AMTF0805W1R0□ST	1.00	J,K	12	7.9	1.00	430	360
AMTF0805W1R2□ST	1.20	J,K	12	7.9	1.15	410	350
AMTF0805W1R5□ST	1.50	J,K	12	7.9	1.20	400	300
AMTF0805W1R8□ST	1.80	J,K	12	7.9	1.35	380	300
AMTF0805W2R2□ST	2.20	J,K	12	7.9	1.50	350	170
AMTF0805W2R7□ST	2.70	J,K	12	7.9	1.70	320	100
AMTF0805W3R3□ST	3.30	J,K	12	7.9	1.80	300	90
AMTF0805W3R9□ST	3.90	J,K	12	7.9	1.95	280	90
AMTF0805W4R7□ST	4.70	J,K	12	7.9	2.05	250	85
AMTF0805W5R6□ST	5.60	J,K	12	7.9	2.30	240	70
AMTF0805W6R8□ST	6.80	J,K	12	7.9	2.60	220	55
AMTF0805W8R2□ST	8.20	J,K	12	7.9	3.00	180	50
AMTF0805W100□ST	10	J,K	10	2.5	2.55	150	40
AMTF0805W120□ST	12	J,K	10	2.5	3.50	100	16
AMTF0805W150□ST	15	J,K	10	2.5	4.20	100	16
AMTF0805W180□ST	18	J,K	10	2.5	4.50	95	15
AMTF0805W220□ST	22	J,K	10	2.5	6.00	80	14
AMTF0805W270□ST	27	J,K	10	2.5	10.7	60	17
AMTF0805W330□ST	33	J,K	10	2.5	10.7	60	17
AMTF0805W390□ST	39	J,K	10	2.5	10.0	60	14
AMTF0805W470□ST	47	J,K	10	2.5	13.8	55	14
AMTF0805W680□ST	68	J,K	8	2.5	17.5	40	11
AMTF0805W101□ST	100	J,K	8	1	25.0	30	5
AMTF0805W111□ST	110	J,K	8	1	26.0	20	5

SHENZHEN MICROGATE TECHNOLOGY CO., LTD.

Add: Microgate Technology Building, No. 16, Technology Road, Pingshan, Shenzhen, China.

Tel: +86-755-28085000

Fax: +86-755-28085605

Postcode: 518122

5/15

## 6. Electrical Performance

Inductance; Q factor

Inductance; Q factor shall meet item 5 when measured on the condition of Table 1.

Table 1

Measuring Equipment	Impedance analyzer keysight E4982A or equivalent
Measuring Frequency	Item 5
Measuring signal level	-13dBm
Measuring Fixture	keysight 16197A

DC Resistance

D.C Resistance shall meet item 5 when measured on the condition of Table 2.

Table 2

Measuring Equipment	LCR Meter HIOKI 3542 or equivalent
---------------------	------------------------------------

Self-Resonant Frequency (S.R.F)

S.R.F. shall meet item 5 when measured on the condition of Table 3.

Table 3

Measuring Equipment	Impedance analyzer Agilent E4991A, Network analyzer Keysight E5071C or equivalent
---------------------	-----------------------------------------------------------------------------------

Rated current

Temperature rise no more than 40°C against chip surface temperature when the allowable current is applied.

Table 4

Measuring Equipment	DC Power Supplier, Current Meter, Thermometer
---------------------	-----------------------------------------------

7. Reliability

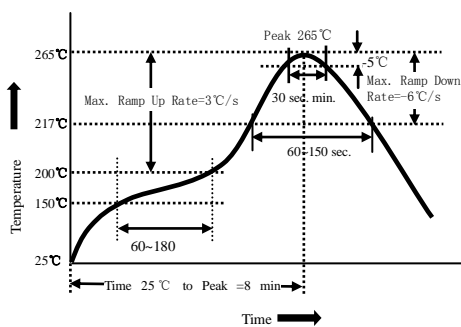
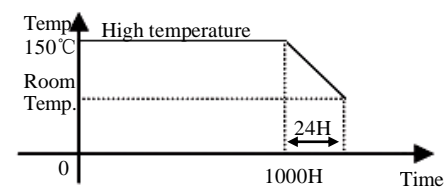
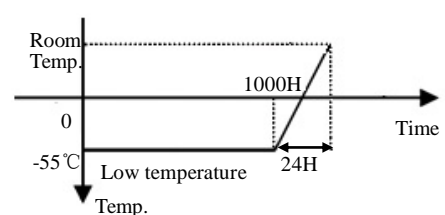
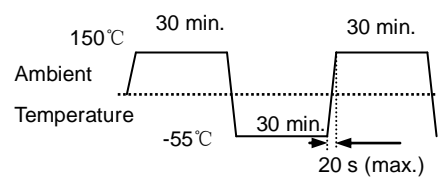
No.	Item	Requirements	Test Methods and Remarks	Reference	Sample Size
1	Solderability	Terminal area shall be at least 95% covered .	①Temperature: $245 \pm 5^{\circ}\text{C}$ , flux 5-10 s. ②Sample immersion tin furnace $3 \pm 1\text{s}$ . ③Sn/3.0Ag/0.5Cu	AEC-Q200	15
2	Resistance to Soldering Heat		①The peak temperature: $260+5/-0^{\circ}\text{C}$ . ②Reflow: 3times. ③Temperature curve is as below: 	AEC-Q200	30
3	High Temperature Storage	(1) No case deformation or change in appearance. (2) $ \Delta L/L0  \leq 5\%$ (3) $ \Delta Q/Q0  \leq 20\%$ (4) $ \Delta DCR/DCR0  \leq 10\%$	①Temperature: $150 \pm 2^{\circ}\text{C}$ . ②Time : 1000(+48,0) hours. ③Measurement at $24 \pm 4$ hours after test conclusion. 	AEC-Q200	77
4	Low Temperature Storage		①Temperature: $-55 \pm 2^{\circ}\text{C}$ . ②Time : 1000(+48,0) hours. ③Measurement at $24 \pm 4$ hours after test conclusion. 	AEC-Q200	77
5	Thermal shock		①First $-55^{\circ}\text{C}$ for 30 minutes, last $150^{\circ}\text{C}$ 30minutes as 1 cycle. Go through 1000 cycles. ②Max transfer time is 20 second. ③Measurement at $24 \pm 4$ hours after test conclusion. 	AEC-Q200	30

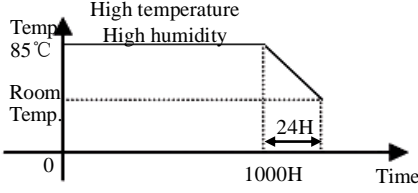
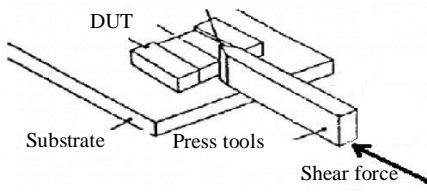
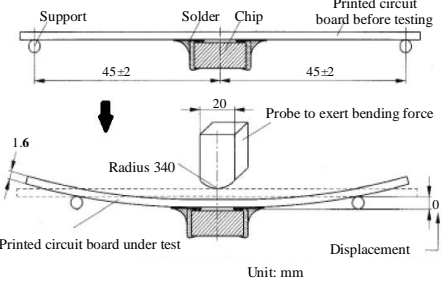
6	Humidity Resistance	<p>(1) No case deformation or change in appearance.</p> <p>(2) <math> \Delta L/L_0  \leq 5\%</math></p> <p>(3) <math> \Delta Q/Q_0  \leq 20\%</math></p> <p>(4) <math> \Delta DCR/DCR_0  \leq 10\%</math></p>	<p>①1000(+48,0) hours, 85 °C/85% RH.</p> <p>②Unpowered.</p> <p>③Measurement at 24±4 hours after test conclusion.</p> 	AEC-Q200	77
7	Terminal Strength	No case deformation or change in appearance.	<p>①The test samples shall be soldered to the board.</p> <p>②A Force of 5N, 5s</p> <p>Radius 1.5mm</p> 	AEC-Q200	30
8	Board Flex	<p>(1) No case deformation or change in appearance.</p> <p>(2) <math> \Delta L/L_0  \leq 5\%</math></p> <p>(3) <math> \Delta Q/Q_0  \leq 20\%</math></p> <p>(4) <math> \Delta DCR/DCR_0  \leq 10\%</math></p>	<p>①Part mounted on a 100mm*40mm FR4 PCB board, which is 0.8mm thick and as a Layer-thickness 35 μm ± 10 μm.</p> <p>②Bending speed is 1mm/s.</p> <p>③Keeping the P.C Board 2 mm minimum for 60 seconds.</p>  <p>Unit: mm</p>	AEC-Q200	30
9	Drop	<p>(1) No case deformation or change in appearance.</p>	<p>①Height: 1 m, Free fall, 10times.</p> <p>②Direction: 1 Angle, 1side, 2surface.</p>	AEC-Q200	30
10	Vibration	<p>(2) <math> \Delta L/L_0  \leq 5\%</math></p> <p>(3) <math> \Delta Q/Q_0  \leq 20\%</math></p> <p>(4) <math> \Delta DCR/DCR_0  \leq 10\%</math></p>	<p>10~2000Hz,5g,20min/Cycle,4 hours in each 3 mutually perpendicular directions (total of 12 hours)</p>	AEC-Q200	30



No.	Item	Requirements	Test Methods and Remarks	Reference	Sample Size
11	Mechanical Shock	(1) No case deformation or change in appearance. (2) $ \Delta L/L_0  \leq 5\%$ (3) $ \Delta Q/Q_0  \leq 20\%$ (4) $ \Delta DCR/DCR_0  \leq 10\%$	Half sine shock pulse, 100g, 6ms, 6 shocks in each 3 mutually perpendicular directions (total of 18 shocks)	AEC-Q200	30
12	Loading at High Temperature	(1) No case deformation or change in appearance. (2) $ \Delta L/L_0  \leq 5\%$ (3) $ \Delta Q/Q_0  \leq 20\%$ (4) $ \Delta DCR/DCR_0  \leq 10\%$	①Temperature: $150 \pm 2^\circ\text{C}$ . ②Time : 1000(+48,0) hours. ③Rated current. ④Measurement at $24 \pm 4$ hours after test conclusion.	AEC-Q200	77
13	Loading at Damp Heat	(1) No case deformation or change in appearance. (2) $ \Delta L/L_0  \leq 5\%$ (3) $ \Delta Q/Q_0  \leq 20\%$ (4) $ \Delta DCR/DCR_0  \leq 10\%$	①Temperature: $60 \pm 2^\circ\text{C}$ , Humidity: 90% to 95% RH ; ② Duration: 1000(+48,0) hours ③ current: Rated current. ④Measurement at $24 \pm 4$ hours after test conclusion.	AEC-Q200	77
14	ESD Test	(1) No case deformation or change in appearance. (2) $ \Delta L/L_0  \leq 5\%$ (3) $ \Delta Q/Q_0  \leq 20\%$ (4) $ \Delta DCR/DCR_0  \leq 10\%$	HBM ESD discharge waveform, 8KV	AEC-Q200	15
15	Moisture Resistance	(1) No case deformation or change in appearance. (2) $ \Delta L/L_0  \leq 5\%$ (3) $ \Delta Q/Q_0  \leq 20\%$ (4) $ \Delta DCR/DCR_0  \leq 10\%$	Method106	MIL-STD-202	77
16	Flammability (External Flame)	(1) No case deformation or change in appearance. (2) $ \Delta L/L_0  \leq 5\%$ (3) $ \Delta Q/Q_0  \leq 20\%$ (4) $ \Delta DCR/DCR_0  \leq 10\%$	Method111/UL94	MIL-STD-202	15
17	Resistance to Solvents	(1) No case deformation or change in appearance. (2) $ \Delta L/L_0  \leq 5\%$ (3) $ \Delta Q/Q_0  \leq 20\%$ (4) $ \Delta DCR/DCR_0  \leq 10\%$	Method215	MIL-STD-202	77

\*All above experiments items need 3 Lot., sample size is as specified in the table above.

\*Sample size standard is from AEC-Q200: qualification sample size requirements.

## 8. Recommended Soldering Conditions

### (1) Reflow soldering conditions

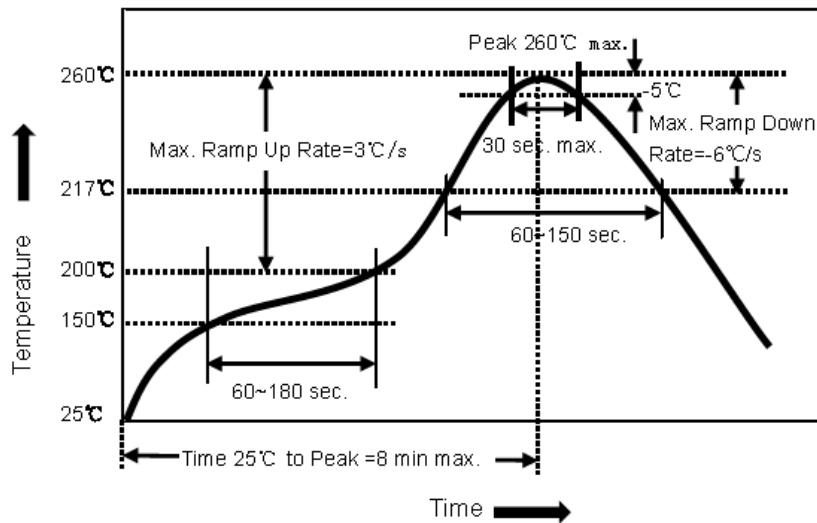

Above reflow soldering curve is from J-STD-020D.

### (2) Solder Volume

Solder shall be used not to be exceeded the upper limits as shown below.

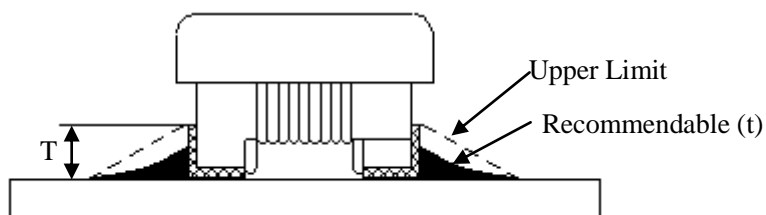

$$1/3T \leq t \leq T$$

(T: Height of electrode)

- Exceeding solder volume may cause the failure of mechanical or electrical performance.
- Before soldering, please ensure that the solder should not adhere to the wire part of chip.
- Please pay particular attention to whether there is flux remaining on surface of the wire part of chip after subjected to reflow soldering since this may causing short circuit of parts.

### (3) Iron soldering

The following conditions must be strictly followed when using a soldering iron.

①

Pre-heating	150°C, 1 minute
Tip temperature	350°C max
Soldering iron output	30w max
End of soldering iron	φ 1mm max
Soldering time	3 seconds max

SHENZHEN MICROGATE TECHNOLOGY CO., LTD.

Add: Microgate Technology Building, No. 16, Technology Road, Pingshan, Shenzhen, China.

Tel: +86-755-28085000

Fax: +86-755-28085605

Postcode: 518122

- ②Don't touch the coil core directly with the top of the iron
- ③In the welding process, the electric iron cannot bump into the enamel-insulated wire, lest components should have evidence of damage.
- ④The test, link products and so on solder correct and support on both sides the method contrast wrongly:

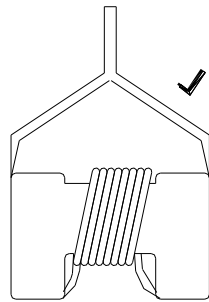

Figure 1 Correct method

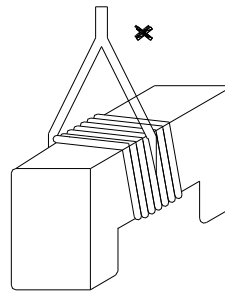
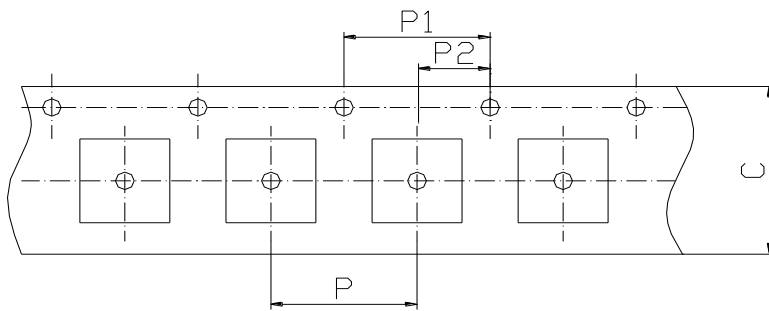

Figure 2 Wrongly method

Tweezers of fixture should support on both sides of the chip, and the correct support way as shown as Figure1. Tweezers of fixture should not support on enamel-insulated wire of the chip, lest enamel-insulated wire should have evidence of damage, the wrong support way as shown as Figure 2.

### 9. Packaging Information

(1) Dimension of tape (Unit: mm)



C	8.0
P	4.0
P1	4.0
P2	2.0

(2) Dimension of reel (Unit: mm)

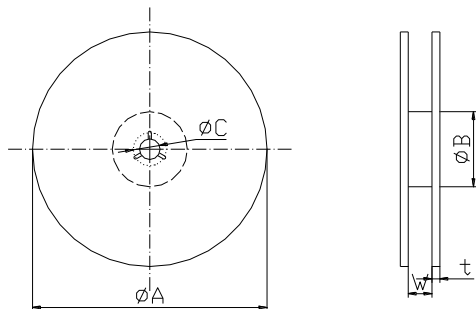

A	180
B	60
C	13
W	10
t	1

(3) Taping figure and drawing direction

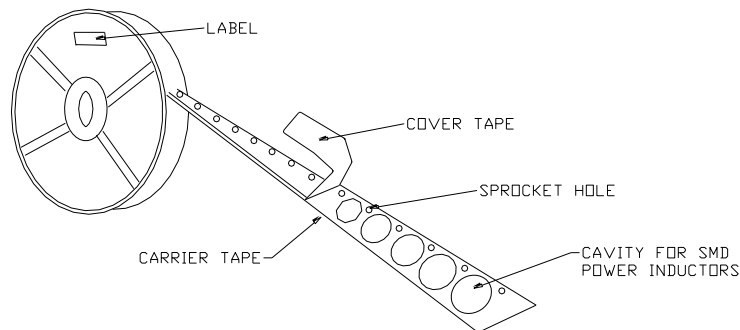

(4) Packaging quantities: 2000PCS/Reel.

(5) Peeling strength of cover tape:

The force tearing off cover tape is 15 to 65 grams in the arrow direction under the following conditions.

Room Temp. (°C)	Room Humidity (%)	Room aim (hpa)	Peel Speed Mm/min
5-35	45-85	860-1060	300

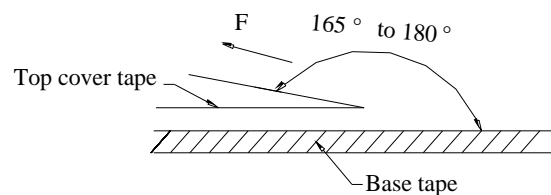

SHENZHEN MICROGATE TECHNOLOGY CO., LTD.

Add: Microgate Technology Building, No. 16, Technology Road, Pingshan, Shenzhen, China.

Tel: +86-755-28085000

Fax: +86-755-28085605

Postcode: 518122

12/15

## 10. Storage

- a. The solder ability of the external electrode may be deteriorated if packages are stored where they are exposed to high temperature or high humidity. Besides, to ensure packing material's good state, packages must be stored at -10°C to 40°C and 15% ~85% RH.
- b. The solder ability of the external electrode may be deteriorated if packages are stored where they are exposed to dust of harmful gas (e.g. HCl, sulfurous gas of H<sub>2</sub>S).
- c. Packaging materials may deform if packages are exposed directly to sunlight.
- d. Minimum packages, such as polyvinyl heat-seal packages shall not be opened until they are used. If opened, use the reels as soon as possible.
- e. Solderability shall be guaranteed for 12 months from the date of manufacture on condition that they are stored at the environment specified in specification. For those parts, which passed more than the time shall be checked solder-ability before use.

## 11. Transportation

The cases shall not be damaged, destroyed and rained on.

## 12. Warning and Attentions

### (1) Precautions on Use

- a. Always wear static control bands to protect against ESD.
- b. Any devices used (soldering iron, measuring instruments) should be properly grounded.
- c. Use non-magnetic tweezers when handing the chips.
- d. Pre-heating when soldering, and refer to the recommended condition specified in specification.
- e. Don't apply current in excess of the rated current value. It may cause damage to components due to over-current.
- f. Keep clear of anything that may generate magnetic fields such as speakers, coils.
- g. When soldering, the electrical characteristics may be varied due to hot energy and mechanical stress.
- h. When coating products with resin, the relatively high resin curing stress may change the electrical characteristics. For exterior coating, select resin carefully so that electrical and mechanical performance of the product is not affected. Before using, please evaluate reliability with the product mounted in your application set.
- i. When mount chips with adhesive in preliminary assembly, do appropriate check before the soldering stage, i.e., the size of land pattern, type of adhesive, amount applied, hardening of the adhesive on proper usage and amounts of adhesive to use.
- j. Mounting density: Add special attention to radiating heat of products when mounting other components nearby. The excessive heat by other products may cause deterioration at joint of this product with substrate.
- k. Since some products are constructed like an open magnetic circuit, narrow spacing between components may cause magnetic coupling.
- l. Please do not give the product any excessive mechanical shocks in transportation.
- m. Please do not touch wires by sharp terminals such as tweezers to avoid causing any damage to wires.
- n. Please do not add any shock and power to the soldered product to avoid causing any damage to chip body.
- o. Please do not touch the electrodes by naked hand as the solderability of the external electrodes may deteriorate by grease or oil on the skin.

## (2) PCB Bending Design

The following shall be considered when designing and laying out PCB's.

1. PCB shall be designed so that products are not subjected to the mechanical stress from board warp or deflection.

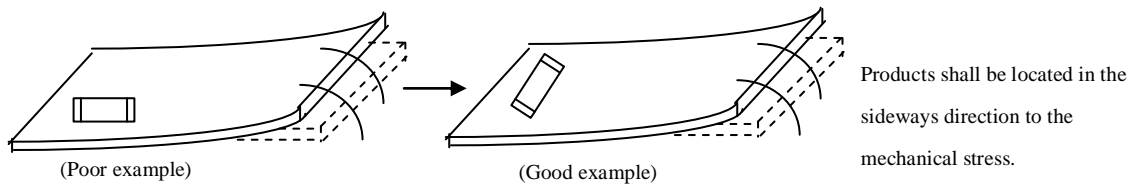

2. Products location on PCB separation.

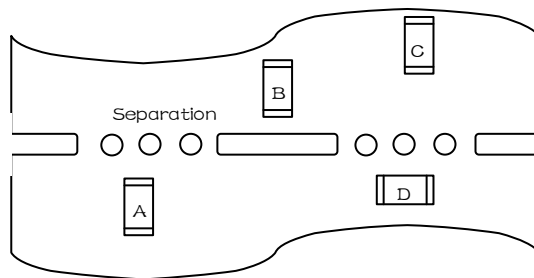

Product shall be located carefully because they may be subjected to the mechanical stress in order of  $A > C = B > D$ .

3. When splitting the PCB board, or insert (remove) connector, or fasten thread after mounting components, care is required so as not to give any stress of deflection or twisting to the board. Because mechanical force may cause deterioration of the bonding strength of electrode and solder, even crack of product body. Board separation should not be done manually, but by using appropriate devices.

## (3) Recommended PCB Design for SMT Land-Patterns

When chips are mounted on a PCB, the amount of solder used (size of fillet) and the size of PCB Land-Patterns can directly affect chip performance. Therefore, the following items must be carefully considered in the design of solder land patterns.

- a. Please use the PCB pad and solder paste we recommend, and contact us in advance if they need to be changed.
- b. The amount of solder applied can affect the ability of chips to withstand mechanical stresses which may lead to breaking or cracking. Therefore, when designing land-patterns it is necessary to consider the appropriate size and configuration of the solder pads which in turn determines the amount of solder necessary to form the fillets.
- c. When more than one part is jointly soldered onto the same land or pad, the pad must be designed that each component's soldering point is separated by solder-resist.

**Recommended land dimensions please refer to product specification.**

### 13. Cleaning

Products shall be cleaned on the following conditions:

- (1) Cleaning temperature shall be limited to 60°C Max. (40°C Max. for IPA)
- (2) Ultrasonic cleaning shall comply with the following conditions, avoiding the resonance phenomenon at the mounted products and PCB.

Power: 20W/1 Max.    Frequency: 28 KHz to 40 KHz    Time: 5 minutes Max

(3) Cleaner

a. Alcohol type cleaner

Isopropyl alcohol (IPA)

b. Aqueous agent

Surface Active Agent Type (Clean through-750H)

Hydrocarbon Type (Techno Cleaner-335)

Higher Alcohol Type (Pine Alpha ST-100S)

c. There shall be no residual flux and residual cleaner after cleaning.

In the case of using aqueous agent, product shall be dried completely after rinse with de-ionized water in order to remove the cleaner.

d. Some products may become slightly whitened. However, product performance or usage is not affected.

e. Please take care of winding part while cleaning.

f. After cleaning, parts could be subjected to the next reflow soldering till the solvent remaining on surface of parts being volatilized.

### 14. Measuring Method of Inductance

(1) Residual elements and stray elements of test fixture can be described by F-parameter shown in following.

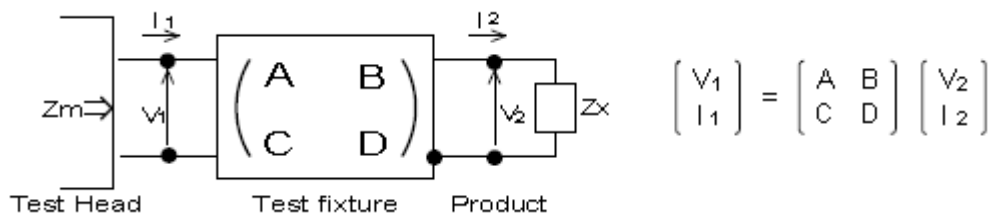

(2) The impedance of chip coil  $Z_x$  and measured value  $Z_m$  can be described by input/output current/voltage.

$$Z_m = \frac{V_1}{I_1} \quad , \quad Z_x = \frac{V_2}{I_2}$$

(3) Thus, the relation between  $Z_x$  and  $Z_m$  is following:

$$Z_x = \alpha \frac{Z_m - \beta}{1 - Z_m \Gamma} \quad \text{where, } \alpha = D / A = 1$$

$$\beta = B / D = Z_{sm} - (1 - Y_{om} Z_{sm}) Z_{ss}$$

$$\Gamma = C / A = Y_{om}$$

(4)  $L_x$  and  $Q_x$  shall be calculated with the following equation.

$$L_x = \frac{\text{Im}(Z_x)}{2\pi f} \quad , \quad Q_x = \frac{\text{Im}(Z_x)}{\text{Re}(Z_x)}$$

$L_x$ : Inductance of chip coil  
 $Q_x$ : Q of chip coil  
 $f$ : Measuring frequency