

CUSTOMER: _____

DATE: _____

APPROVAL SPECIFICATION



PRODUCT NAME: SMD power inductor

YOUR PART NO. :

OUR PART NO. : MPIT8040 Series

VERSION: V2.0

<p>RECEPTION</p> <p>THE SPECIFICATION HAS BEEN ACCEPTED.</p> <p>COMPANY: _____</p> <p>DATE: _____</p>		
CFMD	CHKD	RCVD

MANUFACTURING NAME

SHENZHEN MICROGATE TECHNOLOGY CO., LTD
 Address: Microgate Smart Park, Technology Road, Zhukeng
 Community, Longtian Street, Pingshan District, Shenzhen.
 Postcode: 518122
 TEL: 86-755-28085000
 FAX: 86-755-28085605

CFMD.	CHKD.	DSGD.
Charles	Wang Yusheng	Liu Wei

CATALOG

	Component SPEC Version Record.....	3
1	Scope.....	4
2	Product Identification.....	4
3	Appearance, Dimensions and Material.....	4
4	Testing Conditions.....	5
5	Electrical Characteristics And Test Instruments.....	5-6
6	Reliability.....	7-9
7	Recommended Soldering Conditions.....	9
8	Package Information.....	10
9	Visual inspection standard of product.....	11
10	Products Storage.....	11

Confidential for Microgate

Component SPEC Version Record

Rev.	Effective Date	Changed Contents	Change Reasons	Approved By
1.0	Dec. 10.2012	New released	/	Charles
2.0	JUL. 31.2014	Change the Electrical Characteristics	The Electrical Characteristics improved	Charles

Confidential for Microgate

1. Scope

This specification applies to the MPIT8040 series of SMD power inductor.

2. Product Identification

MPIT 8040 – 1R0 M - LF
① ② ③ ④ ⑤

- ① Product Symbol (T type SMD power inductor)
- ② Product dimensions (8.0×8.0×4.2mm)
- ③ Inductance Value: (R90:0.90 uH 1R0: 1.0uH 100:10uH; 101: 100uH)
- ④ Inductance Tolerance: (M: ±20% ; N: ±30%)
- ⑤ Lead free product.

3. Appearance, Dimensions and Material

3.1 Appearance and dimensions

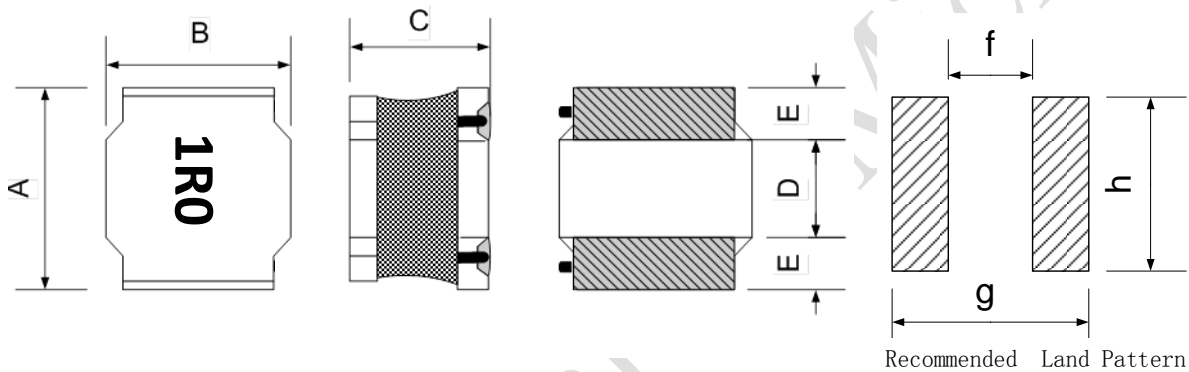

Dimensions in mm							
A	B	C	D	E	f	g	h
8.0±0.3	8.0±0.3	4.2 Max.	3.8 ±0.3	2.10±0.30	3.8 Typ.	8.2 Typ.	7.5Typ.

3.2 Material List

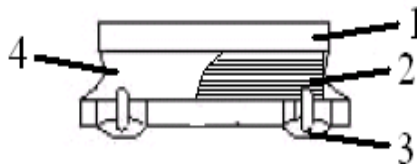

No.	Item	Material
1	Core	Ni-Zn Ferrite
2	Wire	Enameled Copper Wire
3	Terminal Electrode	Ag/Ni/Sn/Cu
4	Magnetic Glue	Epoxy resin and magnetic powder

SHENZHEN MICROGATE TECHNOLOGY CO., LTD.

Add: Microgate Smart Park, Technology Road, Zhukeng Community, Longtian Street, Pingshan District, Shenzhen.

Tel: +86-755-28085000 Fax: +86-755-28085605 Postcode: 518122

4. Testing Conditions

Unless otherwise specified, the standard conditions for measurement/test as:

Ambient Temperature : 5 to 35°C
 Relative Humidity: 25 to 85% RH
 Atmospheric Pressure: 86 to 106 kPa

If any doubt on the results, measurements/tests should be made within the following limits:

Ambient Temperature : 25±1°C
 Relative Humidity: 60 to 70% RH
 Atmospheric Pressure: 86 to 106 kPa

5. Electrical Characteristics And Test Instruments

Microgate Part No.	Inductance L (uH) 100KHz/1V	DCR(Ω)		Isat ^{*1} (A)	Irms ^{*2} (A)
		Max.	Typ.	Max.	Max.
MPIT8040-R68N-LF	0.68±30%	0.007	0.005	15.50	8.00
MPIT8040-R82M-LF	0.82±20%	0.008	0.006	15.20	7.80
MPIT8040-R90M-LF	0.90±20%	0.008	0.006	11.00	7.80
MPIT8040-1R0M-LF	1.0±20%	0.008	0.006	12.00	7.80
MPIT8040-1R5M-LF	1.5±20%	0.010	0.008	10.00	7.00
MPIT8040-2R0M-LF	2.0±20%	0.012	0.009	9.25	6.30
MPIT8040-2R2M-LF	2.2±20%	0.016	0.012	8.30	5.15
MPIT8040-3R3M-LF	3.3±20%	0.020	0.015	7.52	4.90
MPIT8040-4R7M-LF	4.7±20%	0.023	0.018	6.00	4.10
MPIT8040-5R6M-LF	5.6±20%	0.027	0.021	6.00	3.85
MPIT8040-6R8M-LF	6.8±20%	0.031	0.024	4.95	3.70
MPIT8040-8R2M-LF	8.2±20%	0.034	0.026	4.30	3.45
MPIT8040-100M-LF	10±20%	0.038	0.029	4.30	3.30
MPIT8040-120M-LF	12±20%	0.053	0.041	3.55	2.85
MPIT8040-150M-LF	15±20%	0.061	0.047	3.25	2.60
MPIT8040-180M-LF	18±20%	0.068	0.052	3.10	2.45
MPIT8040-220M-LF	22±20%	0.086	0.066	2.80	2.20
MPIT8040-270M-LF	27±20%	0.101	0.078	2.60	2.00
MPIT8040-330M-LF	33±20%	0.125	0.096	2.20	1.80
MPIT8040-390M-LF	39±20%	0.133	0.102	2.10	1.75
MPIT8040-470M-LF	47±20%	0.177	0.136	1.80	1.55
MPIT8040-560M-LF	56±20%	0.192	0.148	1.65	1.45
MPIT8040-680M-LF	68±20%	0.252	0.194	1.50	1.25
MPIT8040-820M-LF	82±20%	0.293	0.225	1.30	1.15
MPIT8040-101M-LF	100±20%	0.377	0.290	1.20	1.00
MPIT8040-121M-LF	120±20%	0.428	0.329	1.15	0.95
MPIT8040-151M-LF	150±20%	0.533	0.410	1.10	0.85
MPIT8040-221M-LF	220±20%	0.702	0.540	0.85	0.80
MPIT8040-331M-LF	330±20%	1.066	0.820	0.70	0.65
MPIT8040-681M-LF	680±20%	2.600	2.000	0.55	0.50
MPIT8040-102M-LF	1000±20%	3.640	2.800	0.43	0.35

SHENZHEN MICROGATE TECHNOLOGY CO., LTD.

Add: Microgate Smart Park, Technology Road, Zhukeng Community, Longtian Street, Pingshan District, Shenzhen.

Tel: +86-755-28085000 Fax: +86-755-28085605 Postcode: 518122

Test instruments and remarks

- * All test data is referenced to 25°C ambient.
- * L test by CHROMA 3302 meter or equivalent.
- * DCR test by Tonghui TH2516B meter or equivalent.
- * CHROMA 3302 and 1320 meter for IDC.
- * Isat: DC current (A) that will cause L0 to drop approximately 30%.
- * Irms: DC current (A) that will cause an temperature rise ΔT approximate to 40°C.
- * The rated current as listed is either the saturation current or the heating current depending on which value is lower.
- * Operating temperature: -40°C to +125°C (Including self-heating)
- * The part temperature (ambient + temp rise) should not exceed 125°C under worse case operating conditions. Circuit design, component placement, PCB trace size and thickness, airflow and other cooling provision all affect the part temperature. Part temperature should be verified in the end application.

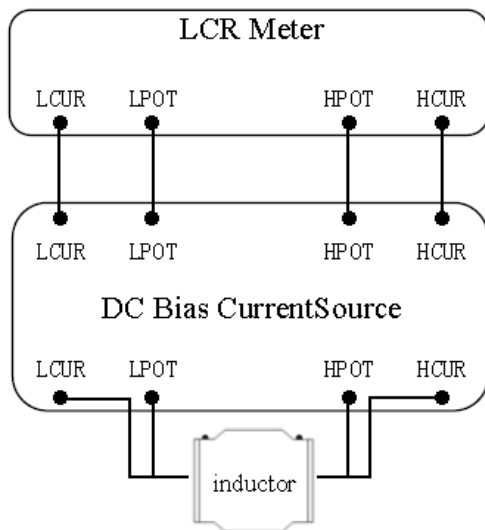

Isat test schematic diagram

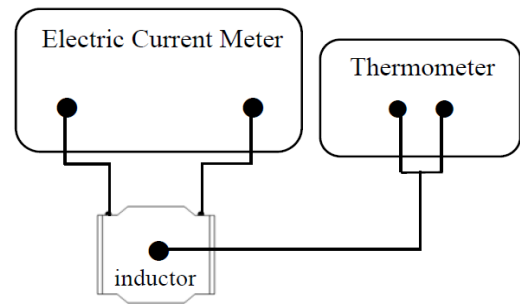

Irms test schematic diagram

6. Reliability

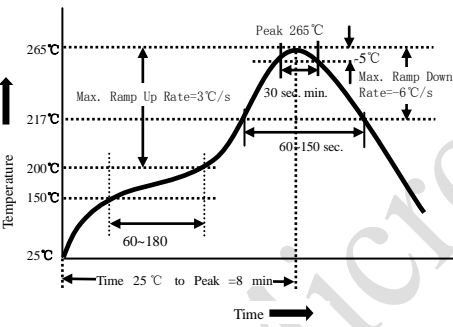
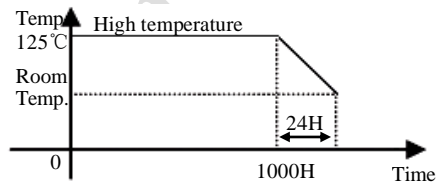
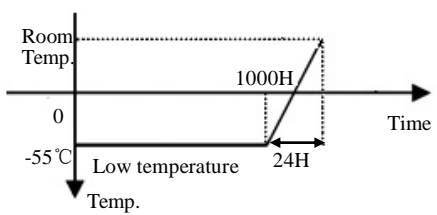
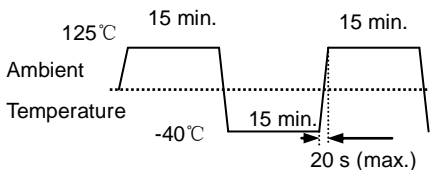
No.	Item	Requirements	Test Methods and Remarks	Reference	Sample Size
1	Solderability	(1) No physical damage. (2) Terminal area must have 95% min. solder coverage.	①Temperature: $245 \pm 5^\circ\text{C}$, flux 5-10 s. ②Sample immersion tin furnace $5 \pm 0.5\text{s}$. ③Immersed and in and out of speed: $25 \pm 6\text{mm/s}$.	AEC-Q200 (J-STD-002)	15
2	Resistance to Soldering Heat		①The peak temperature: $260+5/-0^\circ\text{C}$. ②Reflow: 3times. ③Temperature curve is as below: 	AEC-Q200 (MIL-STD-202 Method 210)	30
3	High Temperature Storage		①Temperature: $125 \pm 2^\circ\text{C}$. ②Time : 1000 hours. ③Measurement at 24 ± 4 hours after test conclusion. 	AEC-Q200 (MIL-STD-202 Method 108)	77
4	Low Temperature Storage	(1) No physical damage. (2) $ \Delta L_0/L_0 \leq 10\%$	①Temperature: $-55 \pm 2^\circ\text{C}$. ②Time : 1000 hours. ③Measurement at 24 ± 4 hours after test conclusion. 	JESD22-A119	77
5	Thermal shock		①First -40°C for 15 minutes, last 125°C 15minutes as 1 cycle. Go through 300 cycles. ②Max transfer time is 20 second. ③Measurement at 24 ± 4 hours after test conclusion. 	MIL-STD-202 Method 107	30

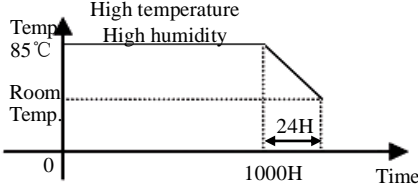
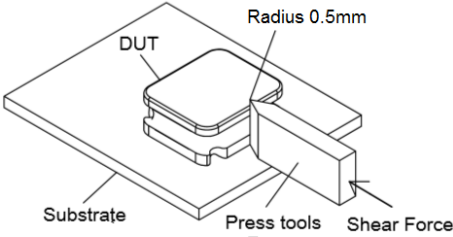
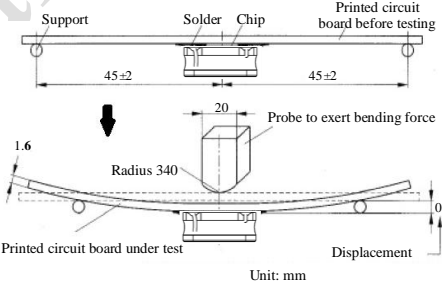
No.	Item	Requirements	Test Methods and Remarks	Reference	Sample Size
6	Humidity Resistance		<p>①1000 hours, 85 °C/85%RH. ②Unpowered. ③Measurement at 24±4 hours after test conclusion.</p>  <p>The graph shows a temperature profile over time. The y-axis is labeled 'Temp' with markers for '85°C', 'High humidity', and 'Room Temp.'. The x-axis is labeled 'Time' with markers for '0', '1000H', and '24H'. The profile starts at 85°C with high humidity for 1000 hours, then ramps down to room temperature, where it remains for 24 hours.</p>	AEC-Q200 (MIL-STD-202 Method 103)	77
7	Terminal Strength		<p>①The test samples shall be soldered to the board. ②17.64N, 60s.</p>  <p>The diagram shows a DUT (Device Under Test) soldered to a substrate. A press tool is used to apply shear force to the terminal. The radius of the terminal is specified as 0.5mm.</p>	AEC-Q200 (AEC-Q200-006)	30
8	Board Flex	<p>(1) No physical damage. (2) $\Delta L/L \leq 10\%$</p>	<p>①Part mounted on a 100mm*40mm FR4 PCB board, which is 1.6 ± 0.2 mm thick and as a Layer-thickness $35 \mu\text{m} \pm 10 \mu\text{m}$. ②Bending speed is 1mm/s. ③Keeping the P.C Board 2 mm minimum for 60 seconds.</p>  <p>The diagram illustrates the board flex test setup. It shows a printed circuit board before testing, supported by two points with a distance of 45 ± 2 mm between them. A chip is soldered to the board. A probe is used to exert bending force on the chip. The board thickness is 1.6 mm, and the radius of the bend is 340 mm. The displacement is measured at the center of the board. The unit is mm.</p>	AEC-Q200 (AEC-Q200-005)	30
9	Drop		<p>①Height: 1 m, Free fall, 10times. ②Direction: 1 Angle, 1side, 2surface.</p>	JESD22-B111	30
10	Vibration		<p>①Frequency range : 10~2000Hz. ②Amplitude: 1.5mm , 5g. ③Sweep time and duration: 10~2000~10Hz for 20 minutes. ④Each four hours(12 times) in X,Y,Z direction, 12 hours in total.</p>	AEC-Q200 (MIL-STD-202 Method 204)	30

SHENZHEN MICROGATE TECHNOLOGY CO., LTD.

Add: Microgate Smart Park, Technology Road, Zhukeng Community, Longtian Street, Pingshan District, Shenzhen.

Tel: +86-755-28085000 Fax: +86-755-28085605 Postcode: 518122

No.	Item	Requirements	Test Methods and Remarks	Reference	Sample Size
11	Loading at High Temperature	(1) No physical damage. (2) $ \Delta L_0/L_0 \leq 10\%$	① Temperature: $85 \pm 2^\circ\text{C}$. ② Time : 1000 hours. ③ Applied Current : Rated current. ④ Measurement at 24 ± 4 hours after test conclusion.	AEC-Q200 (MIL-PRF-27)	77

*All above experiments items need 3 Lot., sample size is as specified in the table above.

*Sample size standard is from AEC-Q200 : qualification sample size requirements.

7. Recommended Soldering Conditions

(1) Reflow soldering conditions

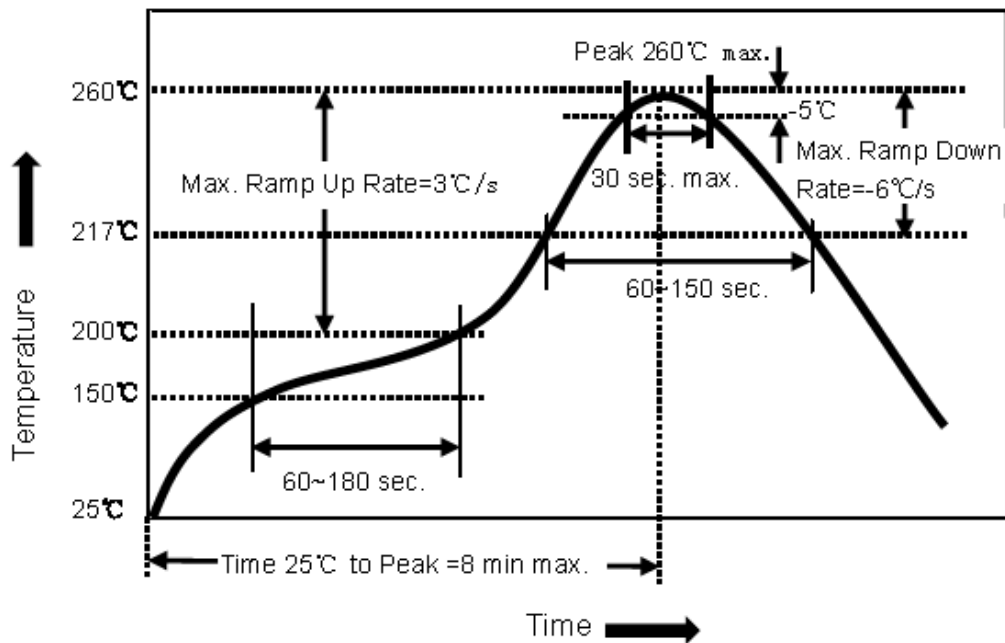

*Above reflow soldering curve is from J-STD-020D.

(2) Iron soldering

The following conditions must be strictly followed when using a soldering iron.

Pre-heating	150°C 1 minute
Tip temperature	350°C max
Soldering iron output	30w max
End of soldering iron	Φ 1mm max
Soldering time	3 seconds max

SHENZHEN MICROGATE TECHNOLOGY CO., LTD.

Add: Microgate Smart Park, Technology Road, Zhukeng Community, Longtian Street, Pingshan District, Shenzhen.

Tel: +86-755-28085000 Fax: +86-755-28085605 Postcode: 518122

8. Package Information

(1) Dimension of tape (Unit: mm)

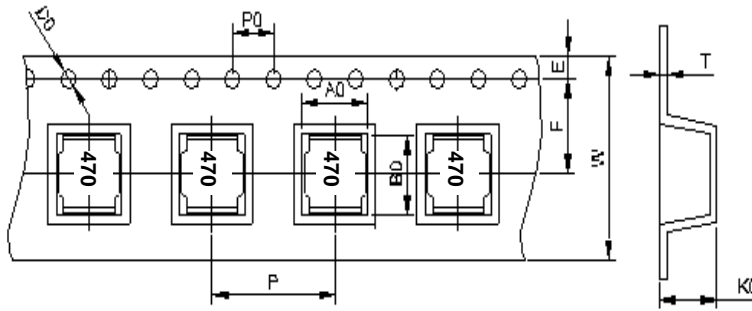

W	A0	B0	K0	E	F	P	P0	D0	T
16.0±0.3	8.35±0.1	8.35±0.1	4.4±0.1	1.75±0.1	7.5±0.1	12.0±0.1	4.0±0.1	1.5+0.1/-0.0	0.40±0.05

(2) Dimension of reel (Unit: mm)

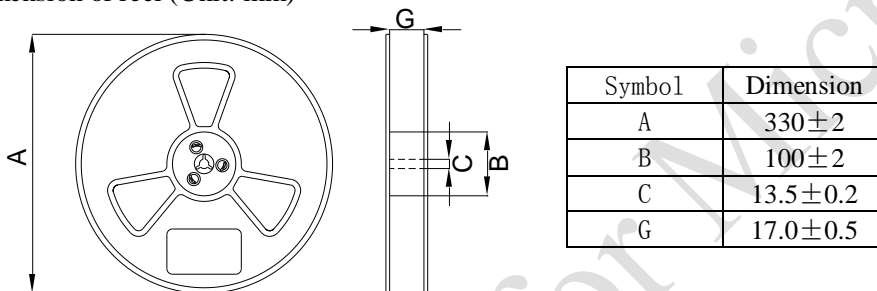

(3) Taping figure and drawing direction

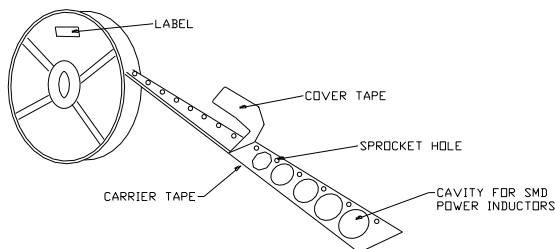

(4) Packaging quantities: 1000PCS/Reel.

(5) Peeling strength of cover tape:

The peel force of top cover tape shall be between 0.10N to 1.3N

*the peel force standard is from EIA-481-D

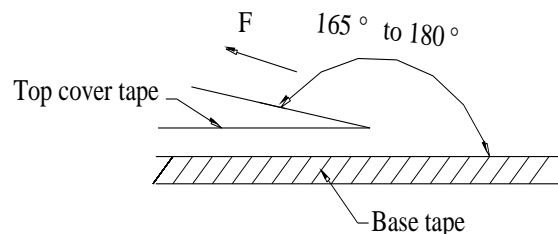

Room Temp. (°C)	Room Humidity (%)	Room aim (hpa)	Peel Speed mm/min
5-35	45-85	860-1060	300

SHENZHEN MICROGATE TECHNOLOGY CO., LTD.

Add: Microgate Smart Park, Technology Road, Zhukeng Community, Longtian Street, Pingshan District, Shenzhen.

Tel: +86-755-28085000 Fax: +86-755-28085605 Postcode: 518122

9. Visual inspection standard of product

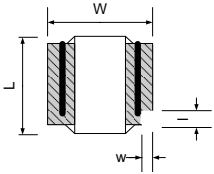
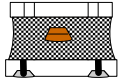
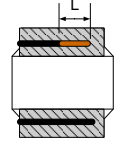
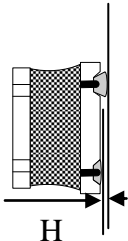
No.	Defect Item	Graphic	Rejection identification	Acceptance
1	Core defect		$l > L/6$ or $w > W/6$, NG.	AQL=0.65
2	Missing resin		The area of missing resin more than 1/3 single face, NG	AQL=0.65
3	Cold solder		L more than 1 mm, NG.	AQL=0.65
4	Solder uneven		$H > 0.1$ mm. NG.	AQL=0.65

10. Products Storage

(1) Storage period

Products which inspected in MICROGATE over 12 months ago should be examined and used, which can be confirmed with inspection No. marked on the container. Solderability should be checked if this period is exceeded.

(2) Storage conditions

Products should be storage in the warehouse on the following conditions:

Temperature: $-10 \sim +35^{\circ}\text{C}$

Humidity: Less than 70% relative and humidity

No rapid change on temperature and humidity.

- (3) Don't keep products in corrosive gases such as sulfur, chlorine gas or acid, or it may cause oxidization of electrode, resulting in poor solderability.
- (4) Products should be storage on the palette for the prevention of the influence from humidity, dust and so on.
- (5) Products should be storage in the warehouse without heat shock, vibration, direct sunlight and so on.
- (6) Products should be storage under the airtight packaged condition.

SHENZHEN MICROGATE TECHNOLOGY CO., LTD.

Add: Microgate Smart Park, Technology Road, Zhukeng Community, Longtian Street, Pingshan District, Shenzhen.

Tel: +86-755-28085000 Fax: +86-755-28085605 Postcode: 518122